

ComboPump REBUILD KIT

Instruction Sheet

Introduction





The **ComboPump rebuild kit** contains all of the components required to replace any and all worn seals. However, rebuilding a ComboPump requires specific skills and tools to be successful. Please read the following instructions completely, before you begin to disassemble the pump. Determine whether you have the requisite skills and tools for this process. We also offer factory repair - please contact your factory representative for more information.

Required Tools

- Medium size flat blade screwdriver
- 1/8" NPT x 3" nipple or equivalent
- Arbor press or small hammer
- Small self tapping or wood screw
- Metal pin, 2 to 2.25 mm diameter, minimum 4 cm length
- Methyl Ethyl Ketone (MEK) or Acetone, used as cleaning solvent
- Compressed air supply
- Silicone grease

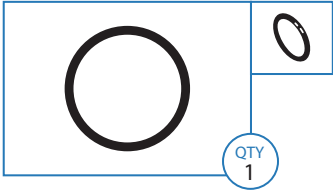
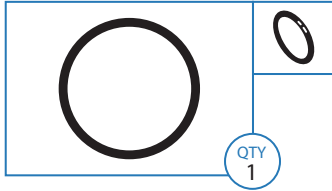

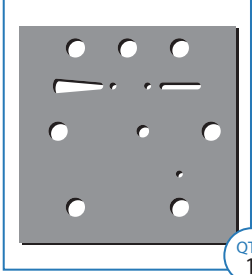
2802 Parts List

O-ring (500 PSI) 10.82mm x 1.78mm 0.426in x 0.070in	O-ring (300 PSI) 12.42mm x 1.78mm 0.489in x 0.070in	Check Valve Bodies
		
Gasket	Label	
		

In addition to the o-rings and parts listed to the left, this rebuild kit contains seven (7) o-rings *not used* in the procedures outlined in this booklet. These o-rings are required only in circumstances where a deeper level of rebuild is called for, and should only be installed by a factory-trained technician. The additional o-rings are listed here for reference only.

	17.12mm x 2.62mm 0.674in x 0.103in QTY 1
	6.07mm x 1.78mm 0.239in x 0.070in QTY 5
	4.47mm x 1.78mm 0.176in x 0.070in QTY 1

Notes:

This kit contains o-rings for both the 300 PSI and 500 PSI ComboPumps. (The smaller o-ring is used for the 500 PSI model.) The full-size o-ring diagrams may not reproduce to scale when printed from the pdf download. All o-ring dimensions provide first the inside diameter, then the thickness.

Disassembly Instructions

- 1 Remove the vent knob by unscrewing it fully counter-clockwise (**figure 1**).
- 2 Remove the ComboPump label from the pump body.
- 3 Remove the seven (7) screws from the Cover Plate (**figure 2**). Although not absolutely necessary, it is easier to disassemble the pump if you secure it in a vise with the facing up.
- 4 Install a 7.5 cm (3 inch) or longer 1/8" NPT pipe nipple into the fitting adjacent to the shuttle valve. Carefully remove the cover plate off by lifting up on the nipple (**figure 3**). You may use a screwdriver instead, levered between the shuttle valve and the jaws of the vise.

WARNING: DO NOT try to separate the cover plate from the pump body by inserting a tool between the two parts - it will damage the sealing surfaces.

- 5 Remove and discard the old main pump gasket.
- 6 Remove the two check valves (**figure 4**). Be certain to note their orientation in the pump body. The top check valve is the pressure side. It can be removed with a pair of small pliers. Do not damage the sides of the hole into which the check valve is installed. The bottom check valve is the vacuum side. It can be removed by screwing a small self-tapping screw (such as a small wood screw) into the small hole and pulling the check valve straight out. Once again, be careful not to damage any sealing surfaces. Discard the check valves.
- 7 For this next step you may use an arbor press, or a small hammer to remove the two (2) pins securing the pump handle assembly to the pump body (**figure 5**). There are two small pins securing the pump handle assembly to the pump body. Place the pump with its bare aluminum surface facing up on a surface with a hole sufficiently large to allow the two pins to pass freely. Place a pin (2 to 2.5mm in diameter) in one of the pin holes. Gently press the pin out of its hole in the Pump Body. Repeat with the second pin. Save the pins, they can be re-used.
- 8 Carefully pull the pump handle assembly free from the pump body.
- 9 Clean all oil contamination from the pump body and cover plate surfaces with a solvent (such as acetone or MEK - methy-

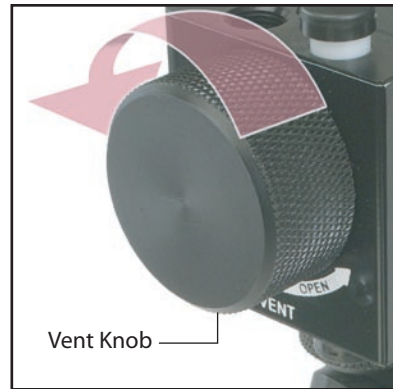

Figure 1

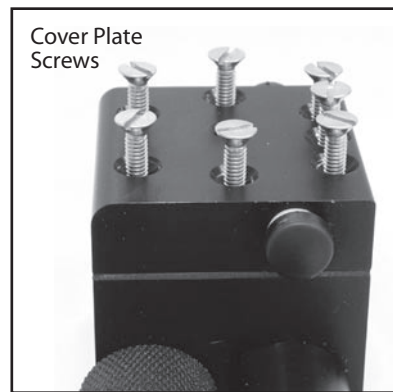

Figure 2

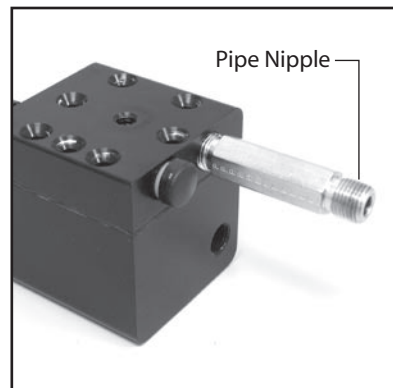

Figure 3

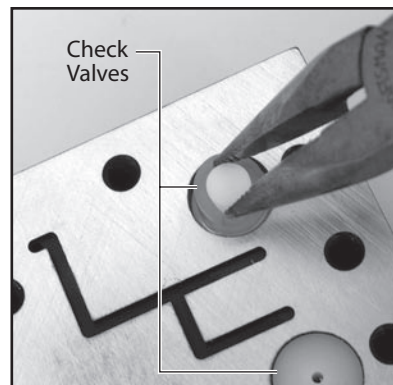

Figure 4

lethylketone) and a cotton swab. Thoroughly blow all parts dry with compressed air. Check to be certain no debris, hair, or cotton swab remnants remain on the pump sealing surfaces.

- 10 Lightly grease the hole for the pump handle assembly and the check valve holes with silicone grease.
- 11 Remove the o-ring from the pump piston on the pump handle assembly and discard it. Clean the o-ring sealing surfaces. Select the proper o-ring from the re-build kit to match the pump's pressure range (300 PSI or 500 PSI). Install the o-ring on the pump piston.
- 12 Install the pump handle assembly into the pump body. Carefully press the two pins into the pump body from the side opposite the bare aluminum surface. Make certain the pins are flush or slightly below the surface of the pump body. You may have to apply a small force against the pump handle assembly while pressing the pins in place.
- 13 Install the two (2) check valves in the pump body holes. Be sure they are correctly oriented.
- 14 Wash your hands to remove all grease and debris.
- 15 Install the main pump gasket on the cover plate. Be certain the gasket fits securely over the protruding pins.

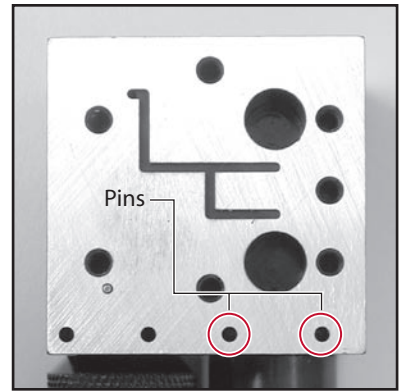
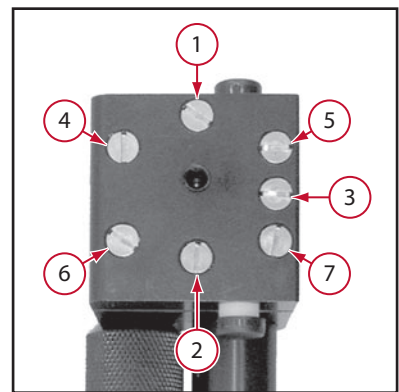

Figure 5



- 16 Place the pump body in the vise. Place the cover plate over the pump body. Install the seven (7) screws, and hand tighten the screws. Tighten the cover plate screws in the order shown at right. This process requires a four (4) step tightening sequence. Allow at least 5 minutes between each tightening to allow the gasket to slowly compress and correctly seal.

TIGHTENING SEQUENCE, 4 STEPS:

- a Tighten 1,2,3,4,5,6,7 – wait 5 minutes
- b Tighten 2,1,7,5,3,4,6 – wait 5 minutes
- c Tighten 1,2,3,4,5,6,7 – wait 5 minutes
- d Tighten 2,1,6,5,7,4,3 – wait 5 minutes

- 17 Trim away any gasket which protrudes from the sides of the pump body with a sharp knife.
- 18 Test the pump for the ability to hold pressure and vacuum. Install the vent knob and plug one port and connect a Digital Test Gauge or Pressure Calibrator to the other port. We recommend testing at two pressure points, 3500 kPa (500 psi), 20kPa (3 psi) and two vacuum points, -80 kPa Hg., and -10 kPa (-1.5 psi) for 15 minutes at each point. This testing will determine whether the repair is successful.
- 19 If the pump does not hold pressure for the 15 minutes, apply a diluted solution of dish washing soap and water to the area where the pump body, cover plate, and pump gasket are connected. If you still cannot determine the source of the leak, contact the factory via any of the methods listed on the next page.
- 20 Clean the outside of the pump body with solvent. After the solvent evaporates install the pump label and the vent knob. This completes the rebuilding process.

How to Contact Us:

Phone (805) 595-5477

Toll-Free (800) 444-1850

Fax (805) 595-5466

Email service@crystalengineering.net

Web www.crystalengineering.net

If calling, have ready the model number, serial number, date of purchase and reason for return. You will receive instructions for returning the device to Crystal Engineering.

Send your comments to: feedback@crystalengineering.net